

Unit: mm

Type A

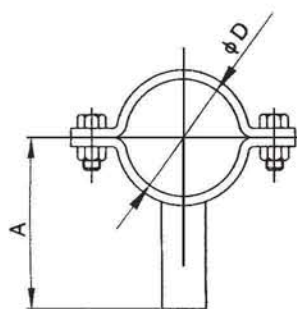

SIZE	A	D
1"	61.0	25.4
1 1/4"	61.0	31.8
1 1/2"	67.0	38.1
2"	74.0	50.8
2 1/2"	80.0	63.5
3"	86.0	76.2
3 1/2"	93.0	89.0
4"	100.0	101.6
4 1/4"	102.0	108.0
4 1/2"	105.0	114.0
5"	115.0	133.0
6"	128.0	159.0

Type B

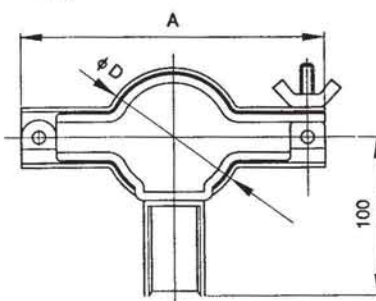

SIZE	A	D
1"	66.0	25.4
1 1/2"	76.0	38.1
2"	90.0	50.6
2 1/2"	105.0	63.5
3"	120.0	76.3
4"	146.0	101.6

Type C

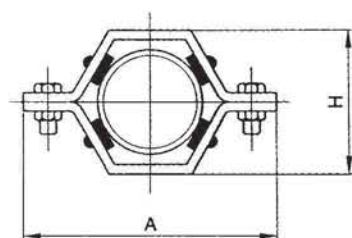

SIZE	A	H
1"	87.0	36.8
1 1/2"	101.6	53.9
2"	114.3	63.5
2 1/2"	120.6	79.4
3"	139.7	95.2
4"	171.4	120.6

Type D

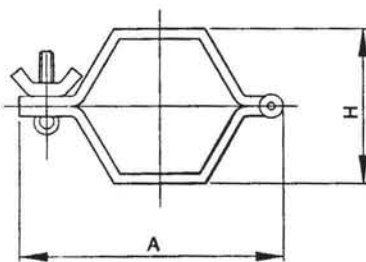

SIZE	A	H
1"	87.0	36.8
1 1/2"	101.6	53.9
2"	114.3	63.5
2 1/2"	120.6	79.4
3"	139.7	95.2
4"	171.4	120.6

Type E

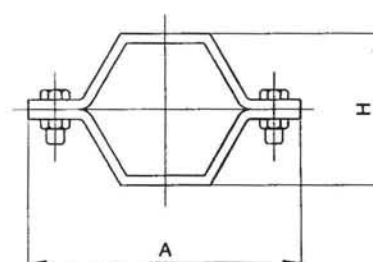

SIZE	A	H
1"	87.0	36.8
1 1/2"	101.6	53.9
2"	114.3	63.5
2 1/2"	120.6	79.4
3"	139.7	95.2
4"	171.4	120.6

Type F

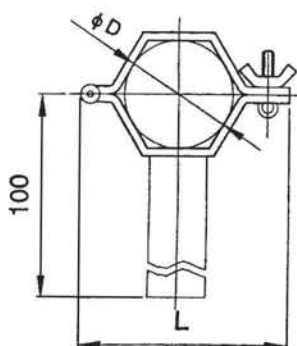

SIZE	A	D	H
1"	61.0	25.0	45.0
1 1/2"	76.0	38.0	51.5
2"	90.0	51.0	58.0
2 1/2"	106.0	63.5	64.0
3"	120.0	76.0	70.5
4"	146.0	101.6	83.0

Type G

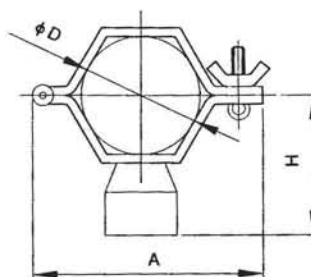

SIZE	A	D	H
1"	61.0	25.0	45.0
1 1/2"	76.0	38.0	54.5
2"	90.0	51.0	58.0
2 1/2"	106.0	63.5	64.0
3"	120.0	76.0	70.5
4"	146.0	101.6	83.0